

2018-2024 Mustang MagneRide® Suspension Lowering Kit Installation Manual

Installation Instructions
P/N: 422330 / 422331



12170 Globe St., Livonia, MI 48150 | [800.59.ROUSH](tel:80059ROUSH)

2018-2024 Mustang MagneRide® Suspension Lowering Kit Installation Manual



Installation Instructions P/N: 422330 / 422331

Application:

2018-2024 Ford Mustang equipped with MagneRide®.

Important Notes:

Suspension Lowering Kit and Calibration Kit are sold as separate items.

Before installing your ROUSH Performance Product(s), read through the entire installation procedure and check to make sure all items are present. Contact ROUSH Customer Service at 1-800-59-ROUSH, weekdays from 9:00 AM to 5:00 PM EST, with any questions regarding fit, missing parts or instructions that are unclear to you.

Table Of Contents

PACKING LIST FOR MAGNERIDE® SUSPENSION LOWERING KIT (422330 / 422331)	3
EQUIPMENT AND SUPPLIES REQUIRED	3
LIMIT OF LIABILITY STATEMENT	5
SAFETY PRECAUTIONS	5
MUSTANG FRONT SUSPENSION REMOVAL:	6
MUSTANG FRONT SUSPENSION SUBASSEMBLY:	9
MUSTANG FRONT SUSPENSION NEW INSTALL:	11
MUSTANG REAR SUSPENSION REMOVAL:	15
MUSTANG REAR SUSPENSION INSTALL:	19
MUSTANG MAGNARIDE® CALIBRATION:	24
MUSTANG MAGNERIDE® BADGE INSTALL:	27

PACKING LIST FOR MAGNERIDE® SUSPENSION LOWERING KIT (422330/ 422331)

Part	Part Number	QTY.
MagneRide® Suspension Kit	422330	1
Front Lowering Spring - V8	60943409	2
Rear LH Lowering Spring - V8	60943408	1
Rear RH Lowering Spring - V8	60943528	1
RETAIL DOCUMENT KIT	RETAILDOC	1
MagneRide® Calibration Kit	422331	1
MAGNERIDE FLASH PAK	1322-MAGFLASH	1
RDT VOUCHER CARD - MAGNERIDE CAL	P1322-MAGRIDE	1
Blank Voucher	CAL-VOUCHER	1
LABEL, MAGNERIDE CALIBRATION	L1322-MAGRIDE	1
RETAIL DOCUMENT KIT	RETAILDOC	1
BADGE - ROUSH MAGNERIDE BWI	1320-32905	1

If you are missing any items, please call us toll free at 1-800-59-ROUSH.

EQUIPMENT AND SUPPLIES REQUIRED

- Impact Gun
- Air Ratchet
- Trim Tool
- Hammer
- UV Marker
- Loctite 242 (Blue)
- 3/8" Square Drive 6mm Hex Bit
- Sockets
 - 10 mm
 - 13 mm
 - 15 mm
 - 18 mm
 - 19 mm
 - 21 mm
 - 24 mm
- 17mm Box End Wrench
- 18mm Box End Wrench
- 19mm Box End Wrench
- 24mm Box End Wrench
- 22mm Socket w/Insert



Rear LH Lowering Spring – 60943408



Rear RH Lowering Spring - 60943528



Front Lowering Spring - 60943409

LIMIT OF LIABILITY STATEMENT

The information contained in this publication was accurate and in effect at the time the publication was approved for printing and is subject to change without notice or liability. ROUSH Performance Parts reserves the right to revise the information presented herein or to discontinue the production of parts described at any time.

SAFETY PRECAUTIONS



CAREFULLY READ THE IMPORTANT SAFETY PRECAUTIONS and WARNINGS BEFORE PROCEEDING WITH THE INSTALLATION!

Appropriate disassembly, assembly methods and procedures are essential to ensure the personal safety of the individual performing the kit installation. Improper installation due to the failure to correctly follow these instructions could cause personal injury or death. Read each step of the installation manual carefully before starting the installation.

- Always wear safety glasses for eye protection.
- Place the ignition switch in the OFF position.
- Always apply the parking brake when working on the vehicle.
- Block the front and rear tire surfaces to prevent unexpected vehicle movement.
- Operate the engine only in well-ventilated areas to avoid exposure to carbon monoxide.
- Do not smoke or use flammable items near or around the fuel system.
- Use chemicals and cleaners only in well-ventilated areas.
- Batteries can produce explosive hydrogen gas which can cause personal injury. Do not allow flames, sparks, or flammable sources to come near the battery.
- Keep hands and any other objects away from the radiator fan blades.
- Keep yourself and clothing away from moving parts when the engine is running.

MUSTANG FRONT SUSPENSION REMOVAL:

1. Lift the front of the car with jack stand or rotary lift and take the front wheels off the vehicle.



2. Remove the front stabilizer bar link upper nut and separate the front stabilizer bar link from the strut and spring assembly.

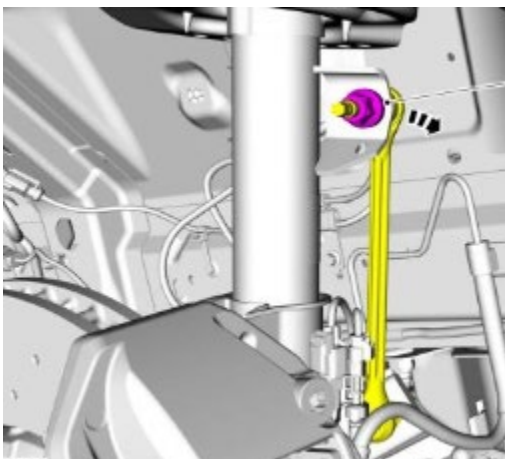

3. Remove the strut wire harness bracket bolt. Disconnect x2 wheel speed sensor retainers and the x1 dynamic suspension strut wire harness retainer.

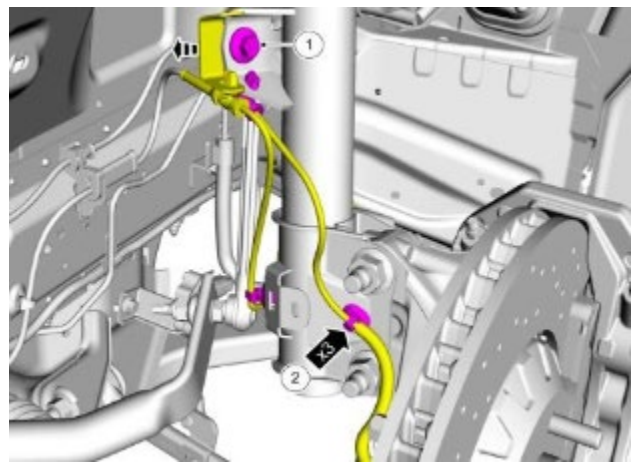

4. Disconnect the brake sensor electrical connector and dynamic suspension strut wire harness connector. Unclip the brake sensor electrical connector and the x2 wire retainers from the strut.

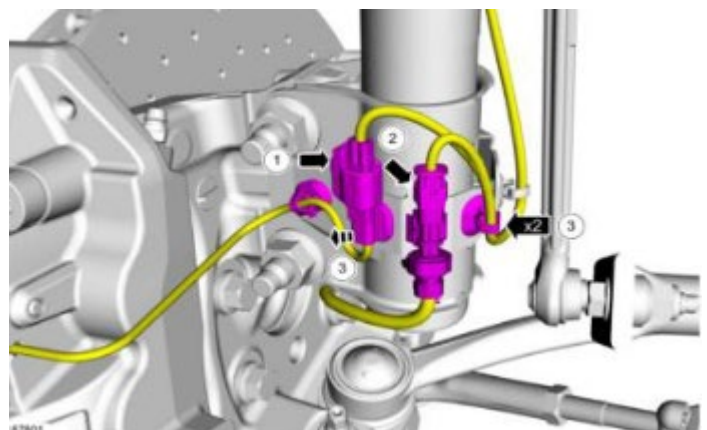

5. Remove the flexible hose bracket mounting bolt.

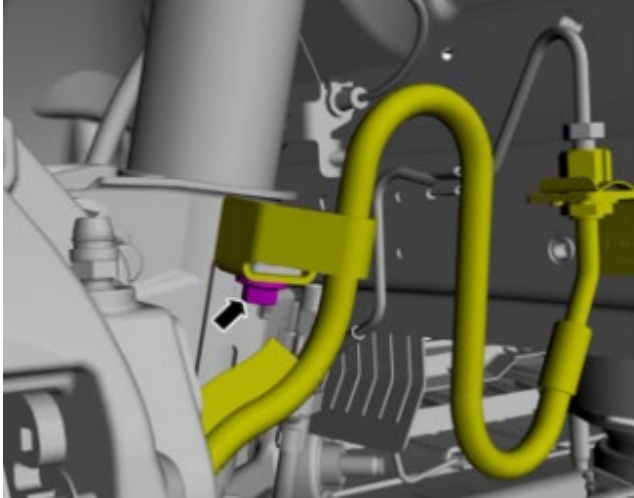

6. Remove and save 2 x brake caliper anchor plate bolts. Remove brake caliper from rotor and place on frame of vehicle. Secure using zip tie or bungee cord, to keep it from falling and damaging caliper.

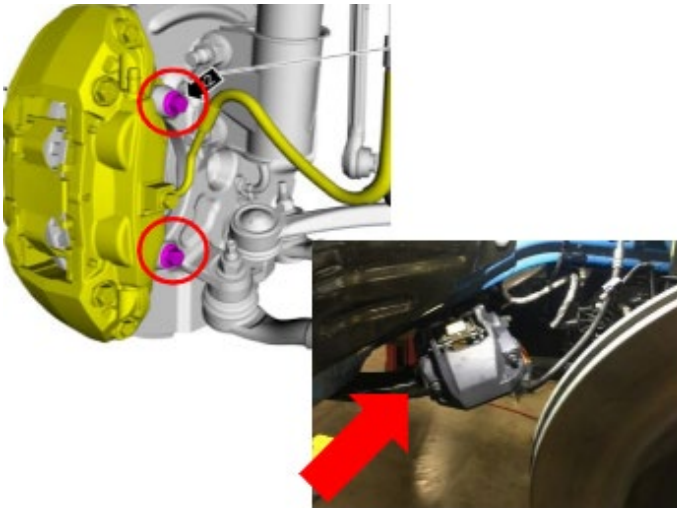

7. Remove rotor from wheel spindle. Save for re-install.



8. Remove and save the x2 strut-to-wheel spindle bolts and nuts. Strut-to-wheel spindle bolts are splined and will need to be driven out. Separate the wheel spindle from the front strut and spring assembly.

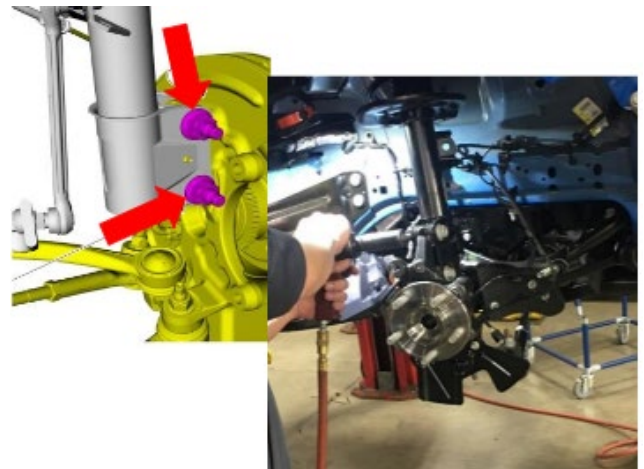

9. Remove and save the x3 upper strut mount nuts. Remove the front strut and spring assembly.

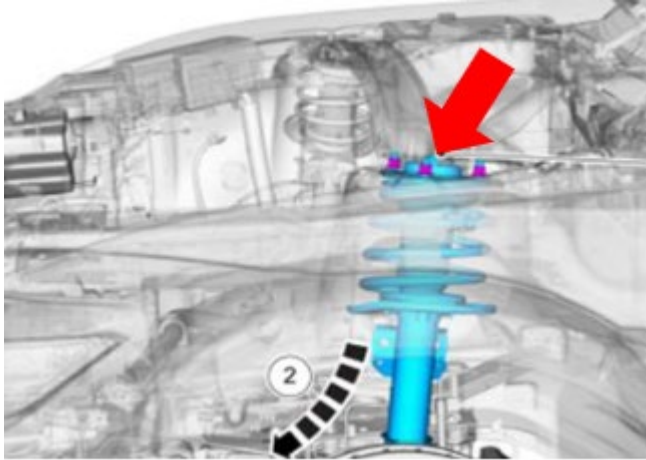

MUSTANG FRONT SUSPENSION SUBASSEMBLY:

**NOTE: FRONT SPRINGS (60943409)
ARE NOT SIDE SPECIFIC**

10. The subassembly requires a spring compression machine, or a spring compressor set.



11. Operate machine to compress the spring and use 21mm impact socket to take nut off and save for re-install. Release spring.



12. Remove Top Hat and Spring from shock. Scrap the old spring and save the top hat for re-install.

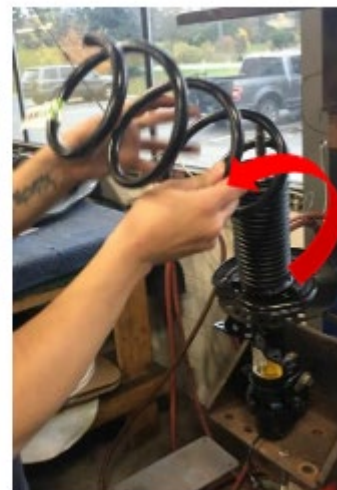

13. Install front lowering spring (60943409) on shock. Align spring end with rubber stop on spring perch.



14. Align the indent on the top hat with the end of spring. Place Top Hat on top of spring and shock.



16. Bolt shock assembly to work bench fixture. Use 21mm torque wrench to torque bolt to 50Nm



15. Use 21mm impact socket to tighten nut.



17. Repeat process for opposite strut.

MUSTANG FRONT SUSPENSION NEW INSTALL:

18. Insert new strut & spring assembly (60943409) in place & get the upper strut mount nuts started on the bolts, (3 Total).



20. Go back and tighten down the upper strut mount bolts, use 15mm socket. (3 Total, Torque = 63 Nm).



19. Insert the knuckle bolts and get those nuts started, (2 Total).



21. Swing the sway bar link back up and into position & insert the bolt through the mounting hole on the strut.



22. Refasten the sway bar link back on to the strut & tighten the lower nut & bolt as well, use a 18mm socket & 17mm wrench. (2 Total, Torque =115 Nm)



23. Put the brake caliper back on the rotor & feed the bolts back in & fasten them, use 15mm socket. (2 Total, Torque = 115 Nm).



24. Refasten the wheel speed sensors back on to the strut, push the clips back in place by hand.



25. Review all your work, pictured is the front suspension totally installed.



26. Reinstall brake caliper and rotor back to wheel spindle.



27. Reconnect brake sensor electrical connector and dynamic suspension strut wire harness connector from step 4.

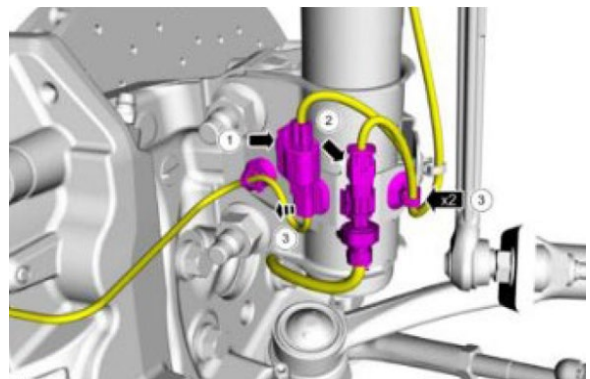

28. Put the tire back on the hub & refasten the lug-nuts use a 21mm socket (5 Total Torque = 150 Nm).



MUSTANG REAR SUSPENSION REMOVAL:

29. Lift the rear of the car with jack stand or rotary lift and take lug nuts off the wheel. Use 21mm socket (5 total)



30. With the key off, unhook the ABS Sensor by hand.



31. Put a jack under the lower control arm & jack up about 4-6 inches to take the tension off.



32. Remove the brake line bracket from the sway bar link, use a 10 mm socket, (1 Total).



33. Remove sway bar link bolt nut, use a 18mm box wrench & a 6mm hex bit, (1 Total).



34. Swing sway bar over to the left out of the way.



35. Remove the brake line bracket, use a 13mm socket (1 Total).



36. Remove lower shock bolts, use 15mm socket, (2 Total).



37. Remove upper shock bolts, use 18mm socket, (2 Total).



39. Move the jack to underneath the sub-frame & jack it up so the lower control arm swings downward.



38. Pull the shock out of the car and set aside.



40. On the far-right hand side remove the sub-frame bolt, use 21mm socket (1 Total). Also remove the subframe bracket bolts, use 13mm socket (2 Total).



41. On the far-left hand side remove the other sub-frame bolt, use 21mm socket (1 Total)



42. Pull down on the rotor & pull the spring out at the bottom to remove entirely from the assembly. When the spring is removed, set it aside.

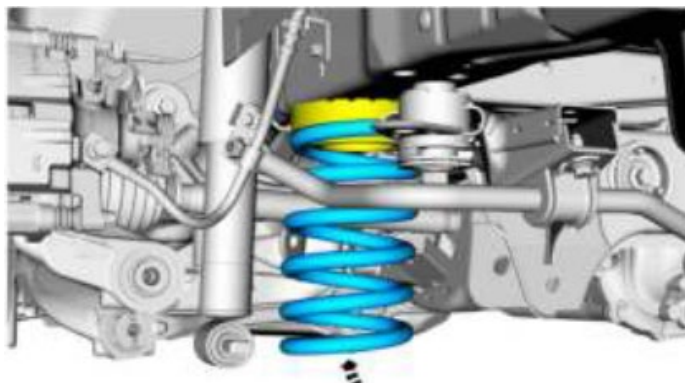

E196074

MUSTANG REAR SUSPENSION INSTALL:

NOTE: REAR SPRINGS ARE SIDE SPECIFIC
LEFT REAR: 60943408
RIGHT REAR: 60943528

43. Make sure the jack is up under the sub-frame & jack it up, so the rotor assembly swings down.

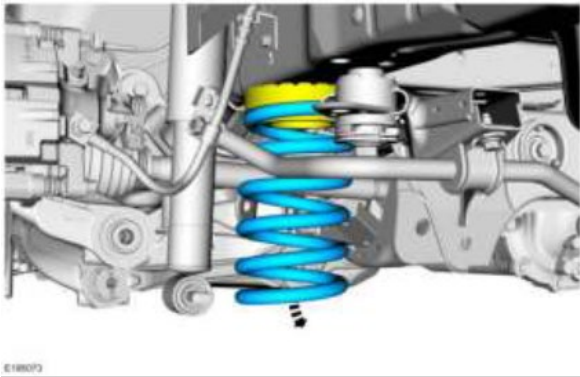

44. Feed the bottom of the spring in first down into place.



45. Make sure the lower end of the spring is butted-up against the stop in the lower coil spring seat. Rotate around if need be.



46. Inspect the placement of the assembly thoroughly before lowering the jack back down.



47. On the far-left hand side refasten the left sub-frame bolt, use 21mm socket (1 Total, Torque = 175 Nm).



48. On the far-right hand side refasten the right sub-frame bolt, use 21mm socket (1 Total, Torque = 175 Nm).



49. Refasten the subframe bracket bolts, use 13mm socket, (2 Total, Torque = 55 Nm).



50. Lower the jack and place it back under the lower control arm and jack the assembly up 2-4 inches.



51. Install the new shock into place.



53. Refasten the upper shock mount bolts, the jack may have to be adjusted, use 18mm socket (2 Total, Torque = 90 Nm)



52. Refasten the lower shock bolts in place by hand to just get them started.



54. Go back and tighten the lower shock bolts in place, use 15mm socket, (2 Total, Torque = 48 Nm).



55. Refasten the brake line bracket back to the frame, use 13mm socket, (1 Total, Torque = 10 Nm).

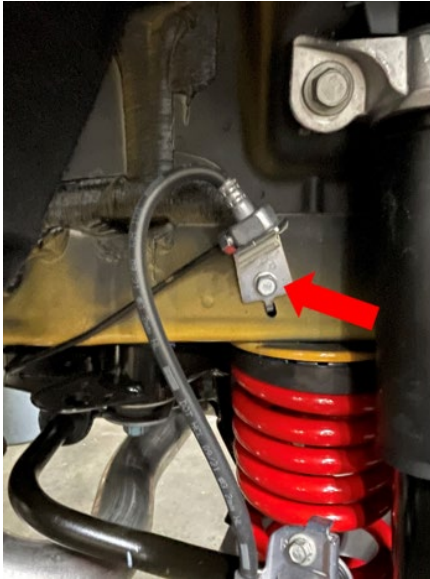

57. Refasten the brake line bracket to sway bar link, use 10mm socket, (1 Total, no Torque, just tight).



56. Refasten the sway bar link bolt nut, use a 18mm box end wrench & a 6mm hex bit, (1 Total, Torque = 115 Nm).



58. Refasten the ABS line back to the bracket, just press back in by hand.



59. Look over your work, this is what the completed rear suspension change over looks like.



60. Put the tire back on the hub & refasten the lug-nuts use a 21mm socket (5 Total Torque = 150 Nm).



61. Repeat process for opposite side.

NOTE: *Roush recommends that a complete vehicle alignment to be performed after the installation of this kit.*

Mustang MagneRide® Calibration(422331)

Please Note: Suspension Lowering Kit and Calibration Kit are sold as separate items.

62. Register and download the Roush Performance App (RDT) to your laptop (Link: <https://rdt.roush.com/RoushRDT/>). Launch RDT from the desktop icon.

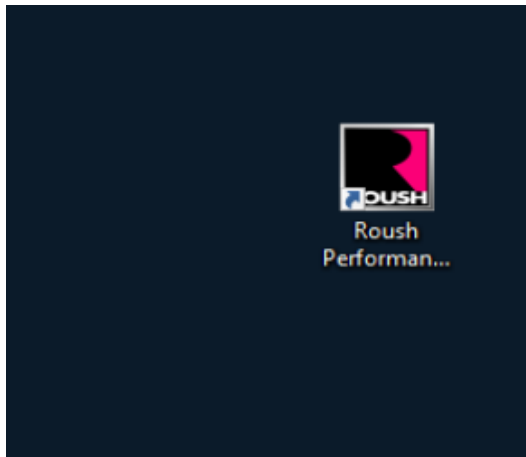

63. Connect diagnostic tool to vehicle.



64. With RDT launched, select 'Module Programming' on the left-hand side of the screen.



65. Click 'VDM Flash.'



66. Obtain flash card, enter 16-digit code, click 'OK' to proceed to flash.
*Note: code is different on each flash card in every kit – this is a one-time use code



67. Click 'Flash.'



68. Click 'OK.'

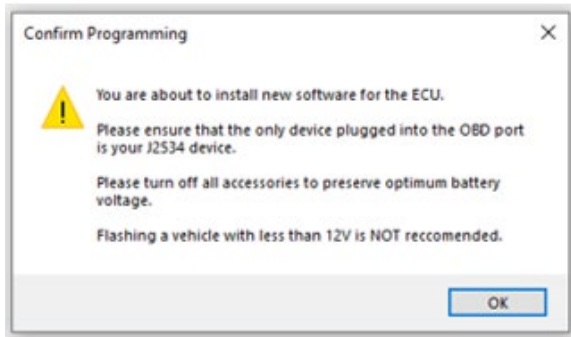

69. Key On and click 'OK.'

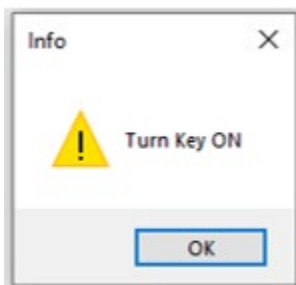

70. Click 'Flash.'



71. Cycle the ignition, click 'OK.'

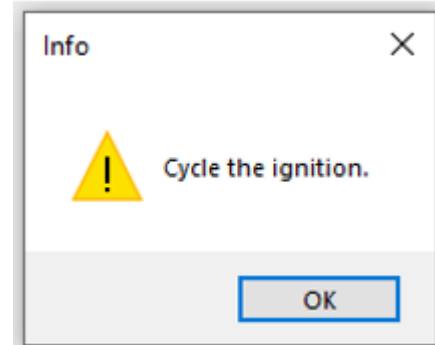

72. Wait until the progress bar at the top of the screen is complete to 100% and click 'OK' before proceeding to the next step.

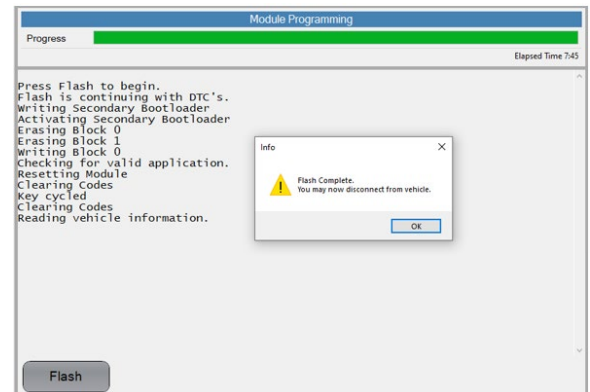

73. Disconnect diagnostic tool from vehicle.



74. Start the vehicle and verify that fault indicator lights are NOT displaying.
*Note: If fault indicator lights are displaying, verify you have completed all the steps in the manual correctly and make sure ALL sensors are plugged into the vehicle. If all sensors are plugged in and fault indicators are displayed restart procedure for reflash. If voucher code is expired contact customer service for new code.



MUSTANG MAGNERIDE® BADGE INSTALL:

75. Locate Mustang MagneRide®
Badge from the kit.



76. Clean the bottom of the center console. Peel back side of the badge and place badge on the bottom of the center console. Locate as picture shown below.
*Note: Firmly press the Badge to ensure the glue is sticking to the center console.



77. The Mustang MagneRide®
Lowering Spring Kit installation is
complete.